

SCHNITT A-A

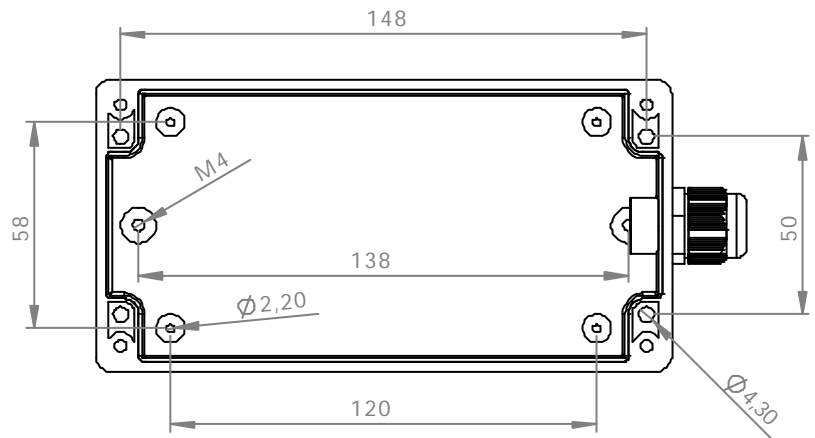
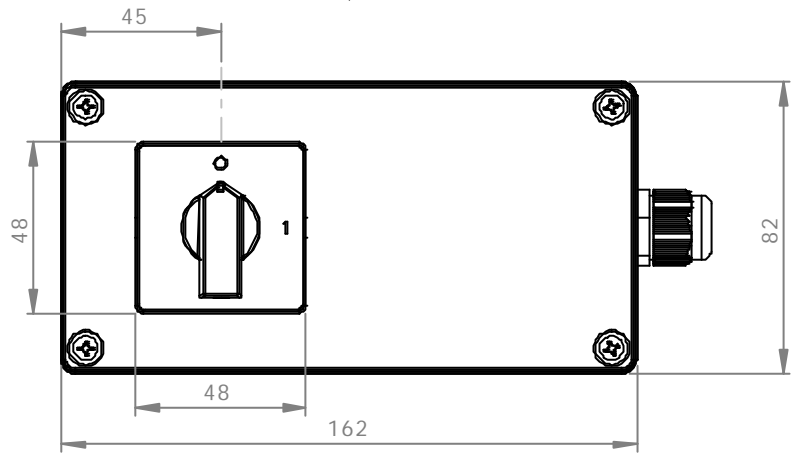

			Tag	Name	Bezeichnung
			Bearb. 15.2.2013	Bo	
			Gepr.		85057223
Ind. Änderung	Tag	Name			ZgNr. G:\SW\Ma\Ku\Intern\