

Ansicht "A"

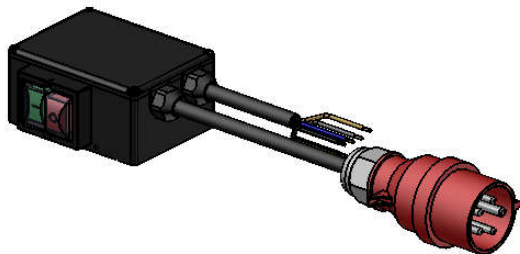
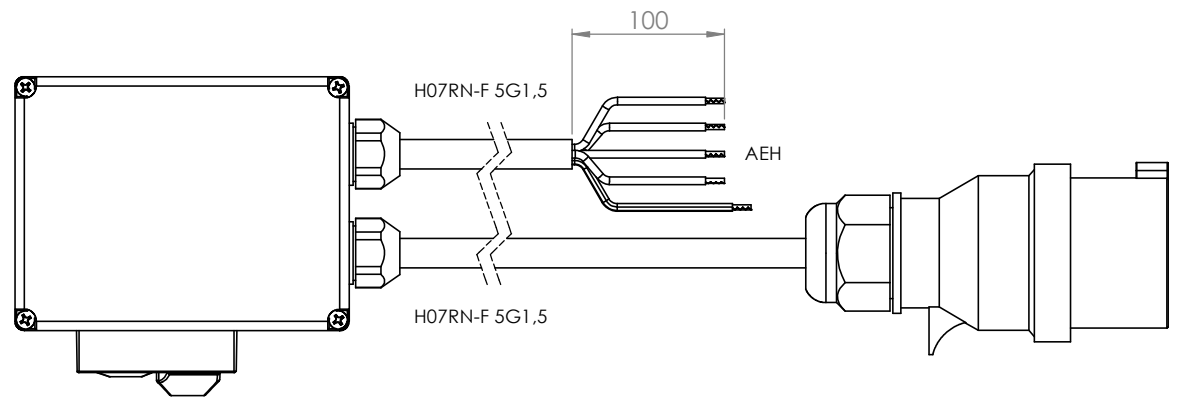
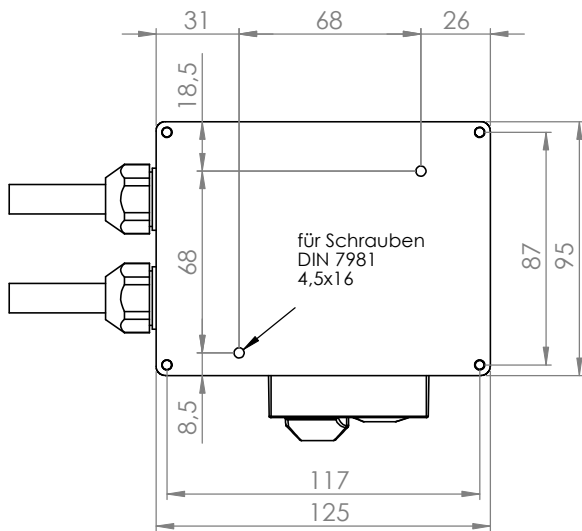

			Tag	Name	Bezeichnung 0098.4230
			Bearb. 26.09.2013	Krämer	
			Gepr.		ZgNr. G:\SW\Ma\Ku\Intern\00984230\
Ind. Änderung	Tag	Name	<b>KLINGER BORN</b>		